



[INCLUSIONI]

GIGACER®

A MIX OF CONTEMPORARY AESTHETICS AND TIMELESS ELEGANCE / UN INCONTRO TRA ESTETICA CONTEMPORANEA ED ELEGANZA SENZA TEMPO

Inspired by the force of the nature, **Inclusioni** blends the intensity of color and the poetry of shape creating endless creative possibilities. Surfaces are authentically material and refined: porcelain stoneware flakes produced under the skilful control of our laboratory technicians are deposited on the surface and incorporated; the result is a tangible and three-dimensional effect.

Five colours available: *Bianco Perla*, *Ecrù*, *Tabacco*, *Cenere* and *Vulcano* ranging from the white to black passing from a heated note of lionate.

There are two versions available of the surface: **Inclusioni Soave** shows the harmony of the materials fused in tones and shapes, whilst **Inclusioni Extrafine** is the final amalgam of the chromatic complex.

Inclusioni Soave has two thicknesses 12 and 24mm with three different surfaces: Mat and Soft especially used for indoor installations or partially covered environments. The third surface available is the Bush-Hammered, with the possibility of making the anti-slip, for design solutions for outdoor and uncovered spaces.

Inclusioni Extrafine is a 6mm thickness with two surfaces: Mat and Levigato. The low thickness allows an easy application of **Extrafine** in coatings or in cases of laying flooring overlapping the existing state, such as in restorations or renovations.

The combination of **Inclusioni** with other materials - such as metal, wood, velvet - creates special accents, expanding the creative possibilities.

Ispirata dalla forza paziente della natura, **Inclusioni** unisce la poesia dei colori e l'espressività delle forme aprendo la strada ad infinite possibilità creative. Le sue superfici sono autenticamente materiche e raffinate: scaglie in gres porcellanato prodotte sotto il sapiente controllo dei tecnici del nostro laboratorio vengono deposte sulla superficie e inglobate; il risultato è un effetto tangibile e tridimensionale.

Cinque i colori degli ambienti: *Bianco Perla*, *Ecrù*, *Tabacco*, *Cenere* e *Vulcano* che spaziano dal bianco al nero passando da una nota riscaldata di lionato. Due le versioni della superficie: **Inclusioni Soave** mostra l'armonia dei materiali fusi nei toni e nelle forme, **Inclusioni Extrafine** è l'amalgama finale del complesso cromatico.

Inclusioni Soave ha due spessori 12 e 24 mm e tre diverse superfici Mat e Soft per gli ambienti interni o parzialmente coperti e il Bocciardato, con possibilità di renderlo antiscivolo, per soluzioni progettuali di spazi all'esterno e scoperti.

Inclusioni Extrafine è di spessore 6 mm con due due superfici Mat e Levigato. Il basso spessore permette una facile applicazione di **Extrafine** nei rivestimenti o nei casi di posa di pavimentazione in sovrapposizione allo stato esistente, come ad esempio nei restauri o nelle ristrutturazioni.

L'accostamento di **Inclusioni** con altri materiali, come il metallo, il legno, il velluto, crea accenti particolari ampliando le possibilità creative.

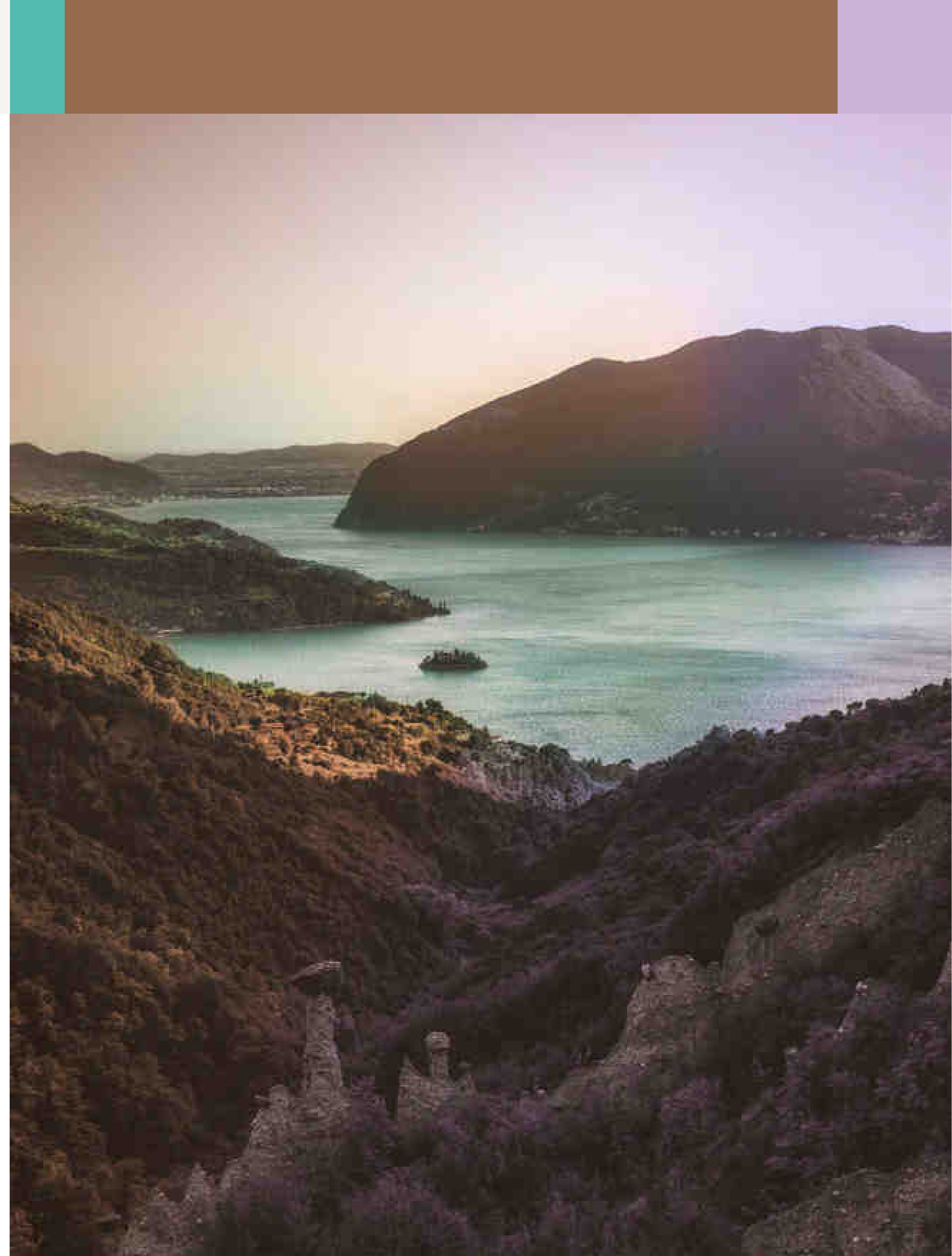

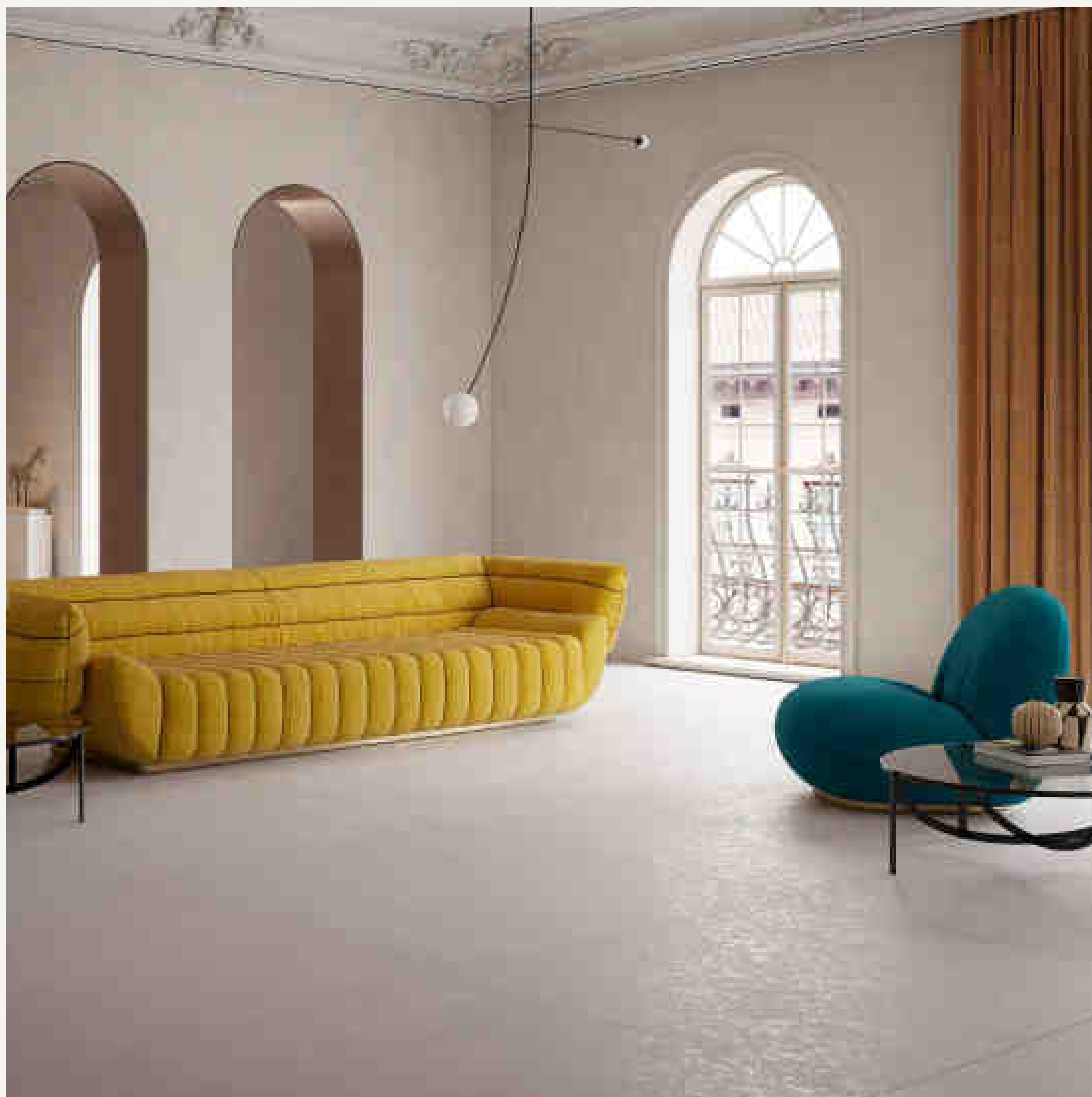

Inspired by the force of the nature, **Inclusioni** is an encounter between contemporary aesthetics and timeless elegance.

INDEX INDICE

2	intro
4	inclusioni / soave
5	sizes and thicknesses formati e spessori
6	colours colori
12	inclusioni / extrafine
13	sizes and thicknesses formati e spessori
14	colours colori
20	projects progetti
32	product guide guida prodotto

[INCLUSIONI]
soave



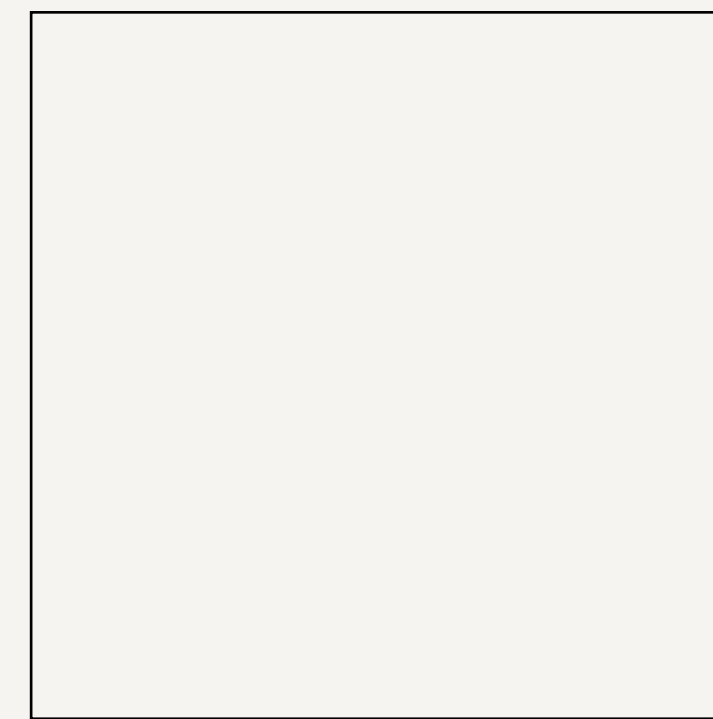
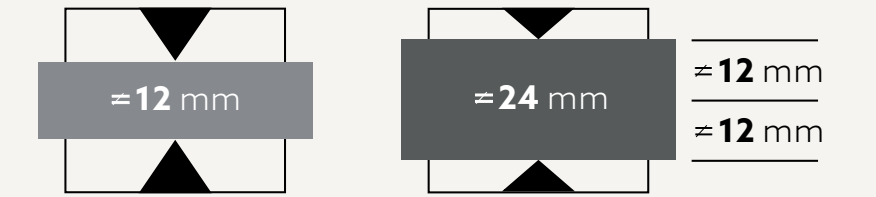

120x120
48"x48"



60x120
24"x48"

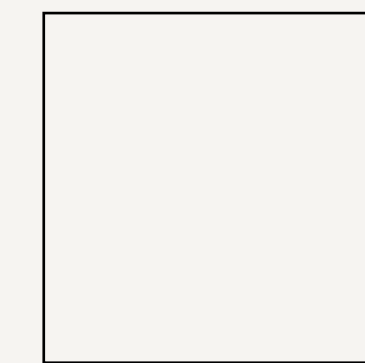

60x60
24"x24"

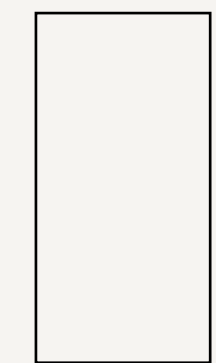

30x60
12"x24"
only/solo ≠ 12 mm



BIANCO PERLA

ECRÙ

TABACCO

CENERE

VULCANO

MAT



SOFT



BOCCIARDATO R10/R11*

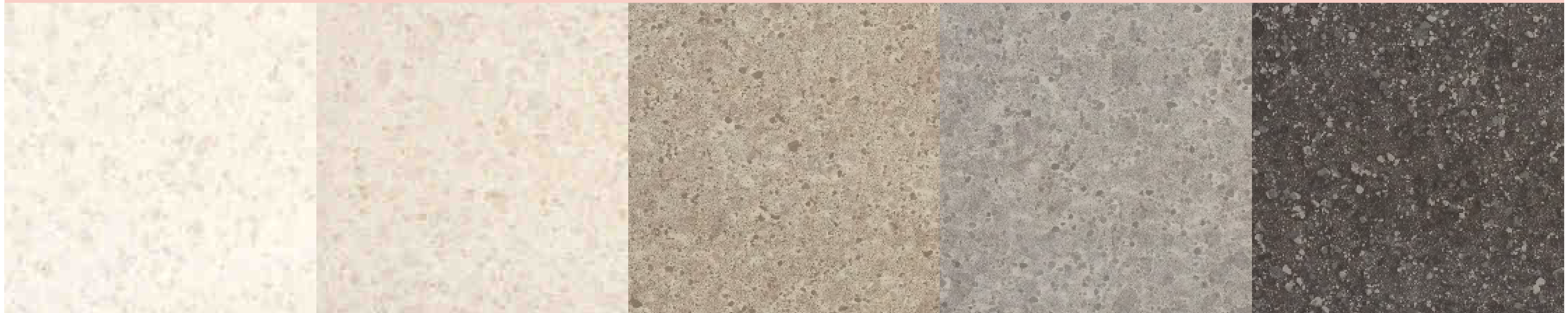

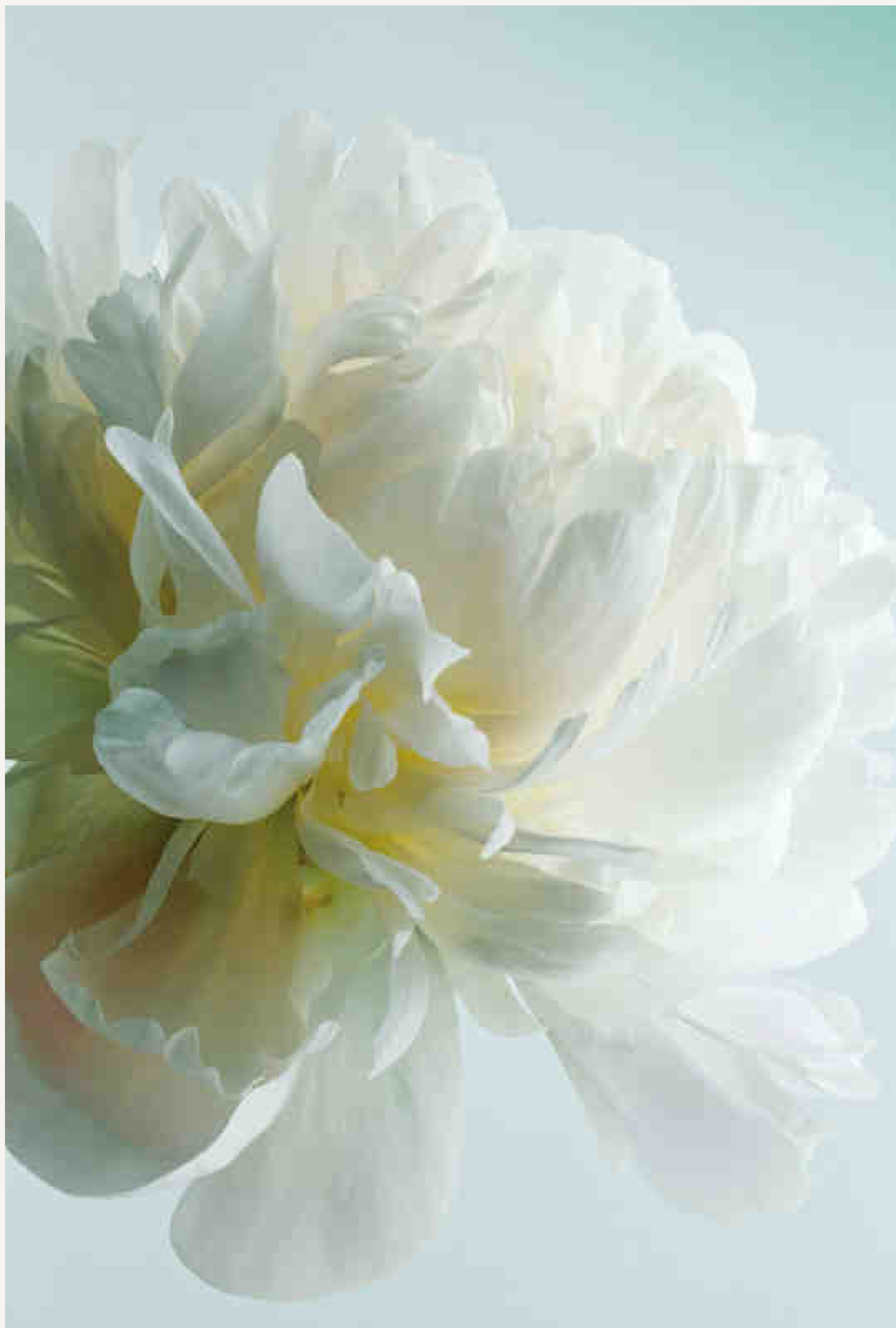

BIANCO PERLA



BOCCIARDATO

MAT

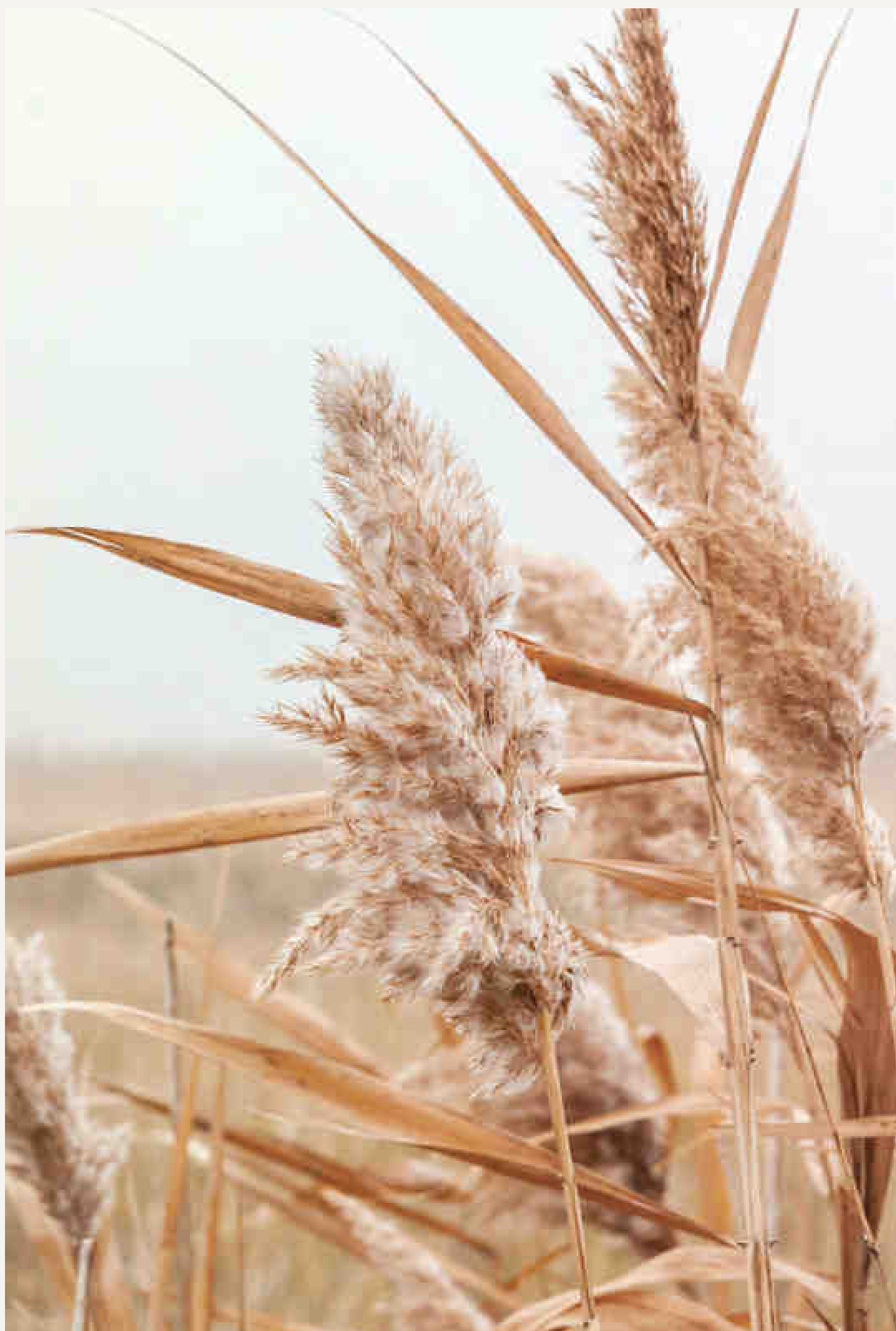

ECRÙ

BOCCIARDATO



MAT



TABACCO



BOCCIARDATO

MAT



CENERE



BOCCIARDATO

MAT

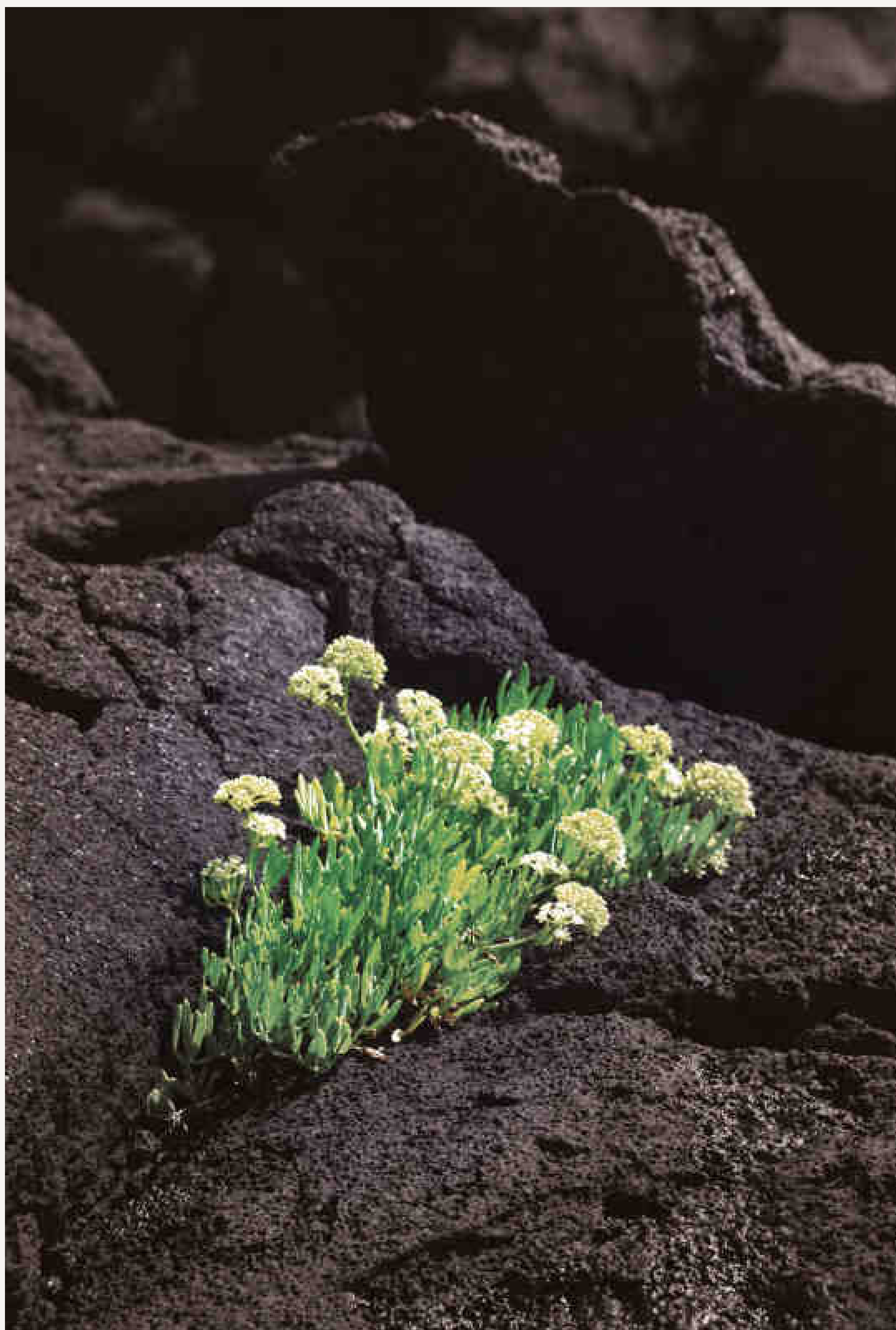

VULCANO

BOCCIARDATO

MAT

[INCLUSIONI]
extrafine

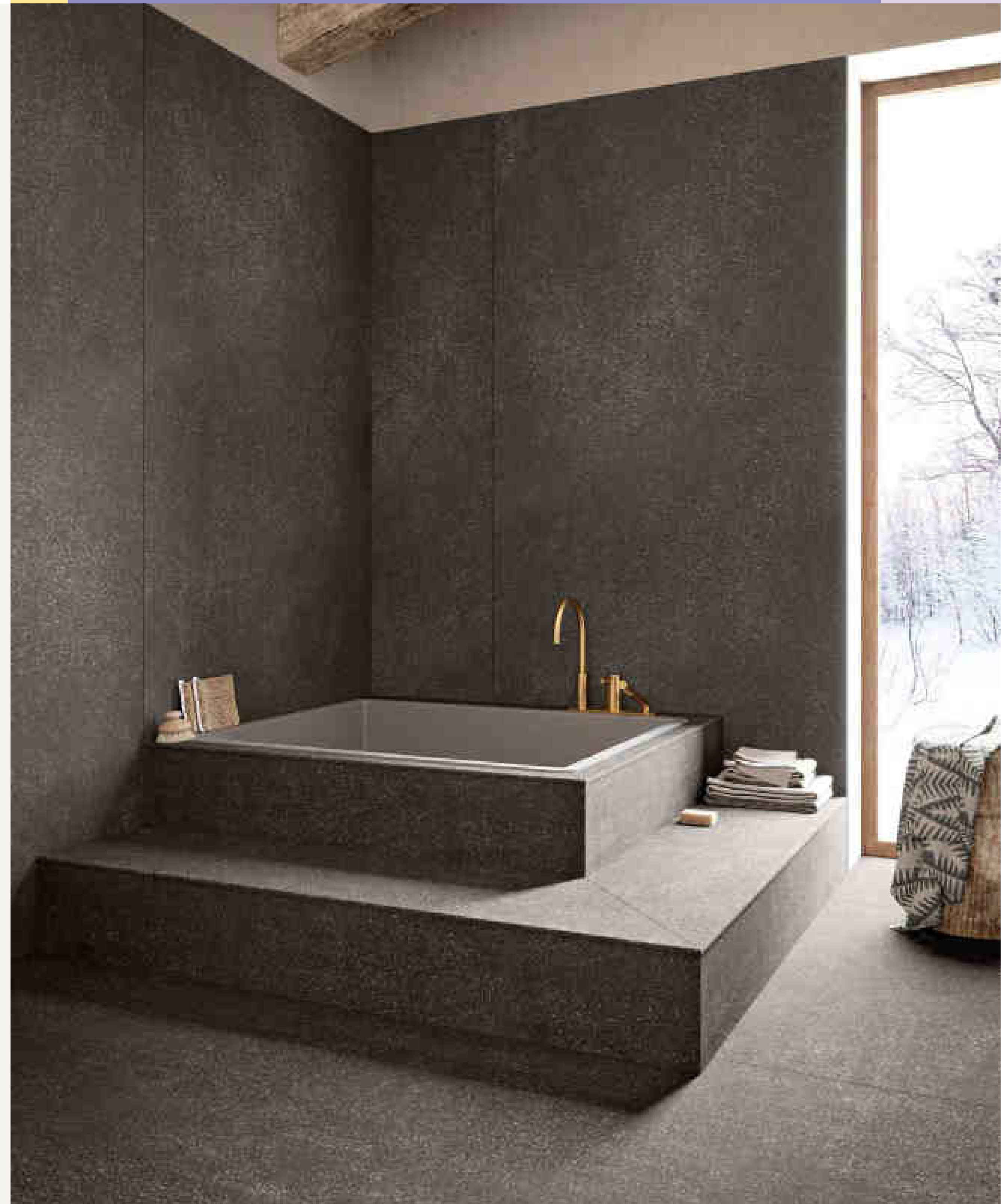

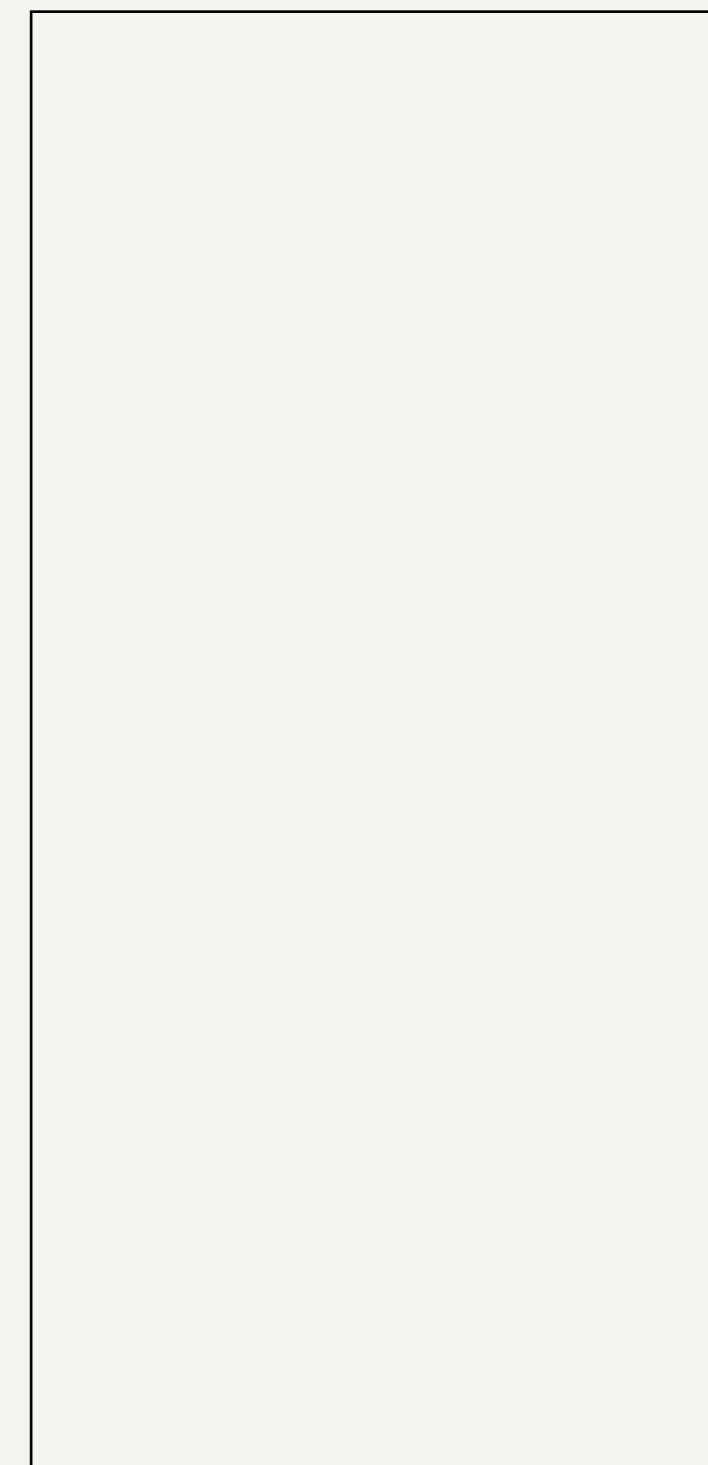

120x250
48"x100"



60x250
24"x100"

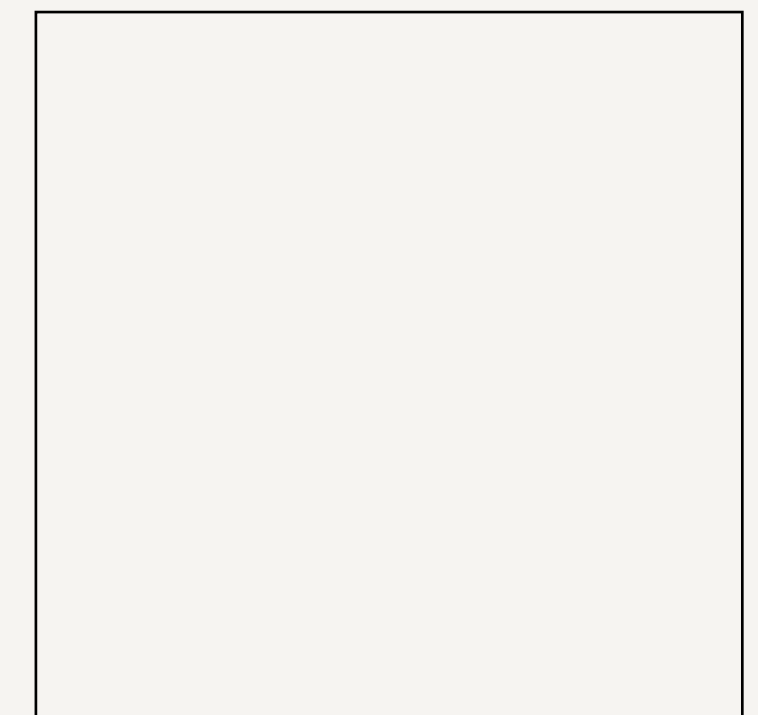

120x120
48"x48"

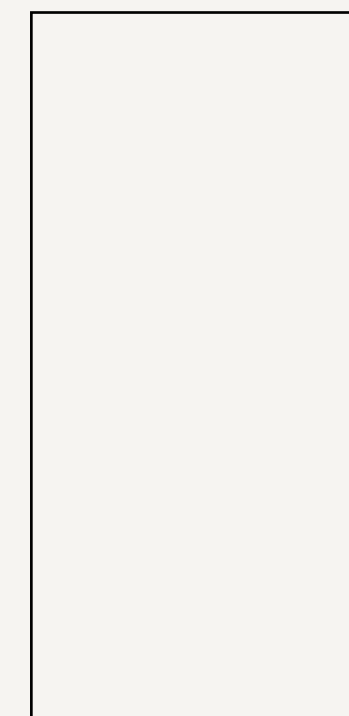
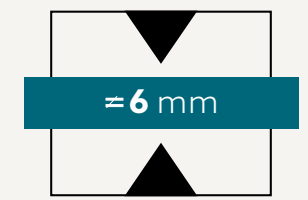

60x120
24"x48"

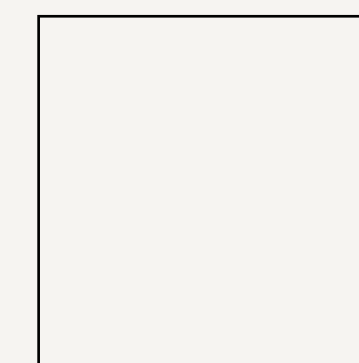

60x60
24"x24"



30x60
12"x24"



The products with the **GIGACER SERVICE** label will be manufactured only upon specific request and they will be quoted where necessary. /
Gli articoli con il marchio **GIGACER SERVICE** saranno prodotti solo su specifica richiesta e quotati ove necessario.

BIANCO PERLA

ECRÙ

TABACCO

CENERE

VULCANO

MAT / LEVIGATO





BIANCO PERLA



LEVIGATO

MAT



ECRÙ



LEVIGATO

MAT



TABACCO

LEVIGATO

MAT



CENERE



LEVIGATO

MAT



VULCANO



LEVIGATO

MAT

PROJECTS PROGETTI





FLOOR | PAVIMENTO
Inclusioni Soave Bianco Perla Soft 120x120 / 48"x48" / #12 mm

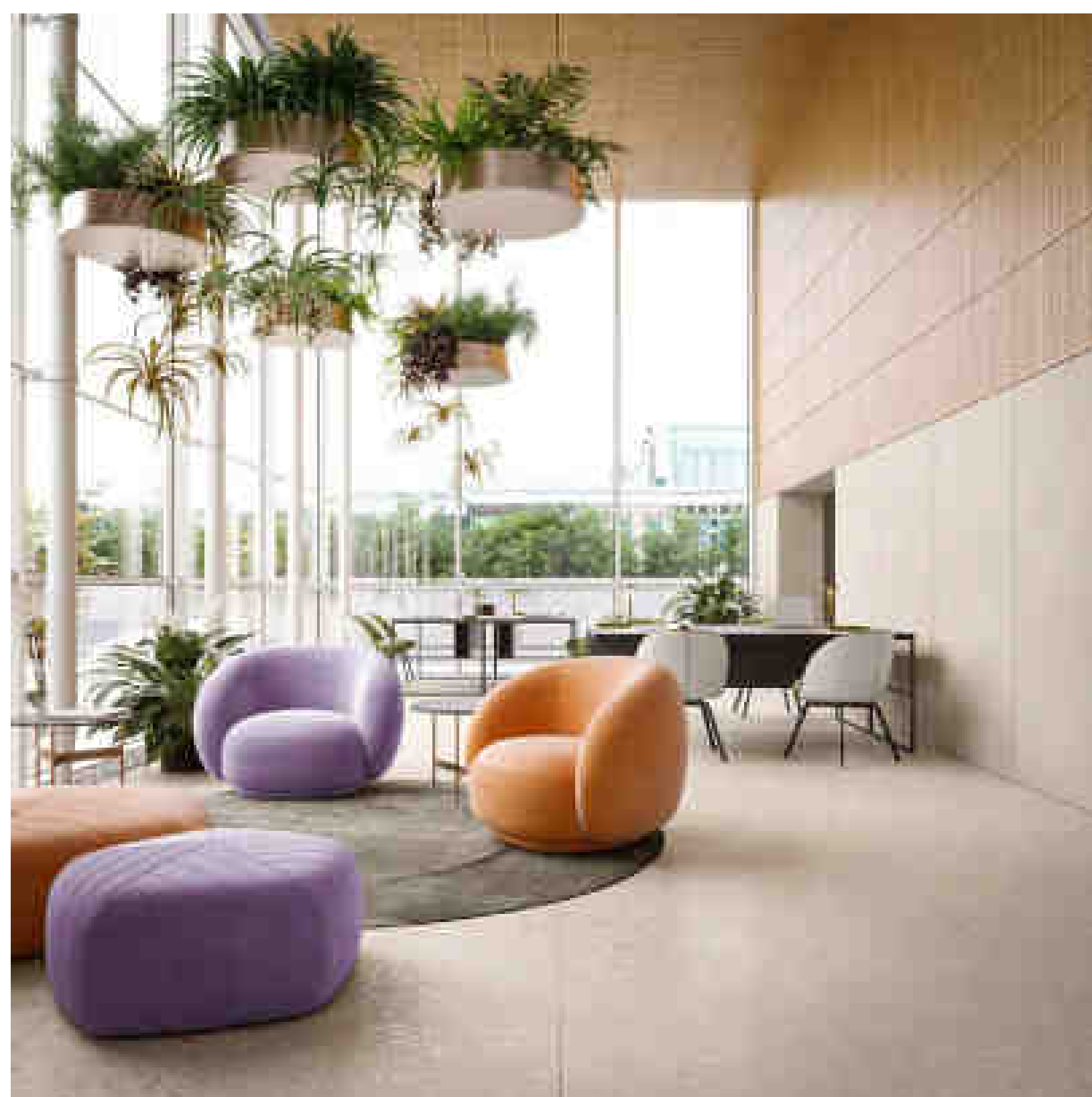

2

- 2.**
 FLOOR | PAVIMENTO
Inclusioni Soave Ecrù Mat 120x120 / 48"x48" / ≠12 mm
 WALL | RIVESTIMENTO
Inclusioni Extrafine Ecrù Mat 120x250 / 48"x100" / ≠6 mm
- 3.**
 FLOOR | PAVIMENTO
Inclusioni Soave Ecrù Soft 120x120 / 48"x48" / ≠12 mm
 WALL | RIVESTIMENTO
Inclusioni Extrafine Ecrù Mat 120x250 / 48"x100" / ≠6 mm



3



FLOOR | PAVIMENTO
Inclusioni Soave Ecrù Mat 120x120 / 48"x48" / #12 mm
Inclusioni Soave Ecrù Bocciardato R11 120x120 / 48"x48" / #24 mm
WALL | RIVESTIMENTO
Inclusioni Extrafine Ecrù Mat 120x250 / 48"x100" / #6 mm



5

5.
FLOOR | PAVIMENTO
Inclusioni Soave Tabacco Bocciardato R11 60x60 / 24"x24" / #24 mm

6.
FLOOR | PAVIMENTO
Inclusioni Soave Ecrù Bocciardato R11 120x120 / 48"x48" / #24 mm



6



7

7. / 8.
 FLOOR | PAVIMENTO
Inclusioni Soave Vulcano Soft 120x120 / 48"x48" / ≠12 mm
 KITCHEN TOP | TOP CUCINA
Inclusioni Extrafine Vulcano Levigato Gigacer Service



8



9

9. / 10.
FLOOR | PAVIMENTO
Inclusioni Soave Tabacco Bocciaurato R11 60x60 / 24"x24"



10



11

11. / 12.
FLOOR | PAVIMENTO
Inclusioni Soave Tabacco Mat 120x120 / 48"x48" / #12 mm



12



13

13.
WALL | RIVESTIMENTO
Inclusioni Extrafine Tabacco Levigato 60x120 / 24"x48" / #6 mm

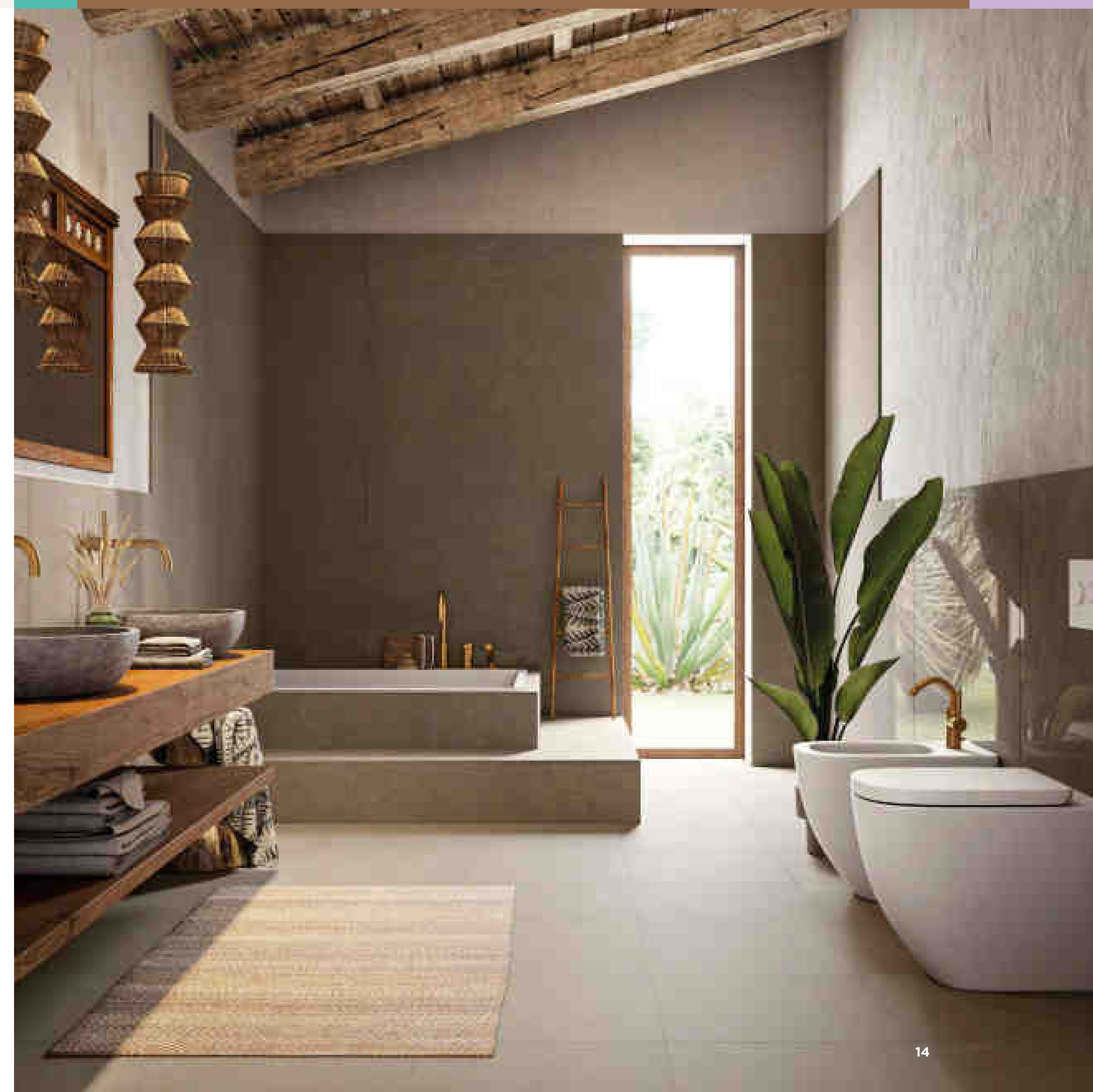

14

14.
FLOOR | PAVIMENTO
Inclusioni Extrafine Tabacco Mat 60x60 / 24"x24" / #6 mm
WALL | RIVESTIMENTO
Inclusioni Extrafine Tabacco Levigato 60x120 / 24"x48" / #6 mm
Inclusioni Extrafine Tabacco Levigato 120x250 / 48"x100" / #6 mm



FLOOR | PAVIMENTO
Inclusioni Soave Cenere Mat 120x120 / 48"x48" / #12 mm
BAR COUNTER | BANCONE
Inclusioni Extrafine Cenere + Vulcano Levigato Gigacer Service / #6 mm



16

16.
FLOOR | PAVIMENTO
Inclusioni Soave Cenere Mat 120x120 / 48"x48" / ≠12 mm

17.
FLOOR | PAVIMENTO
Inclusioni Soave Bianco Perla Mat 120x120 / 48"x48" / ≠12 mm



17



FLOOR | PAVIMENTO
Inclusioni Soave Cenere Mat 120x120 / 48"x48" / #12 mm
DESK | BANCONE
Inclusioni Extrafine Cenere Levigato 120x250 / 48"x100" / #6 mm

PRODUCT GUIDE GUIDA PRODOTTO



SUSTAINABLE THINKING SOSTENIBILITÀ

WE PAY CLOSE ATTENTION TO:

- the safety and comfort of our production staff;
- the respect for the environment in and around the factory;
- the safety of tile layers in the building site, which is guaranteed by the specially designed packaging that makes movement easier and that is completely recyclable.

We manufacture large porcelain slabs thanks to the application of advanced technologies, in accordance with the current European environmental standards (and often with even better results). For this reason the engines are installed in soundproof areas, the lighting around the production area is low emission, there is an environmental monitoring in real time, the complete packaging (sidepack) uses minimum quantities of cardboard and, however, the material used for packaging is completely recyclable and glueless.

TECHNOLOGICAL INNOVATION / AN INTELLIGENT PRODUCTION PROCESS.

GIGACER production process starts from large porcelain slabs, size 120x250 e 120x120 cm, homogeneous multilayer. The slabs can then be cut in many other submultiples and worked again to get different finishes, preserving their top quality and aesthetic features.

These homogeneous multilayer porcelain slabs show superior technical and aesthetic characteristics thanks to a highly innovative technology. The equipment has been realized on purpose to manufacture large sizes and uses an innovative technology called "CONTINUA". This technology foresees a pre-compacting phase before pressing, that allows to achieve special decorative effects without using glazes, but only distributing the porcelain mixed powders on the body. The thickness of the manufactured slabs are 12 mm and 6 mm.

CURIAMO CON PARTICOLARE ATTENZIONE:

- la sicurezza ed il comfort del personale addetto alla produzione;
- il rispetto dell'ambiente in cui sorge lo stabilimento;
- la sicurezza del personale sul cantiere, garantita da imballaggi studiati per facilitare la movimentazione e completamente riciclabili.

Produciamo grandi lastre ceramiche grazie all'applicazione di tecnologie all'avanguardia, nel rispetto (spesso anche in senso molto migliorativo) delle vigenti normative europee sull'ambiente. Per questo i macchinari si trovano in ambienti insonorizzati, l'illuminazione della linea produttiva è a basso regime, esiste un monitoraggio ambientale in tempo reale, il sistema di imballaggio - sidepack - prevede, prima della pressatura, l'utilizzo di quantità di cartone minime e comunque i materiali dell'imballo sono completamente riciclabili e privi di colle.

INNOVAZIONE TECNOLOGICA / UN PROCESSO PRODUTTIVO INTELLIGENTE.

Il processo produttivo di GIGACER prevede la preparazione preliminare di due formati principali, grandi lastre in gres porcellanato 120x250 e 120x120 cm, multistrato o tutta massa, che possono essere successivamente tagliate e modificate a freddo in molteplici altri formati e superfici mantenendo la massima garanzia di requisiti tecnici qualitativi ed estetici.

Questa serie di lastre caratterizzate da superiori prerogative tecniche ed estetiche viene prodotta in gres porcellanato a tutta massa multistrato con una tecnologia assolutamente innovativa. L'impianto è stato progettato appositamente per produrre grandi formati e utilizza la tecnologia definita "CONTINUA" che prevede prima della pressatura, una fase di precompattazione della lastra multistrato a tutta massa che permette di ottenere speciali effetti decorativi senza ricorrere all'uso di smalti, ma solo con la distribuzione di impasti porcellanati colorati di qualità. Gli spessori delle lastre prodotte sono di 12 mm e 6 mm.



EDGE AND WORKTOP MACHINING LAVORAZIONI BORDI E TOP

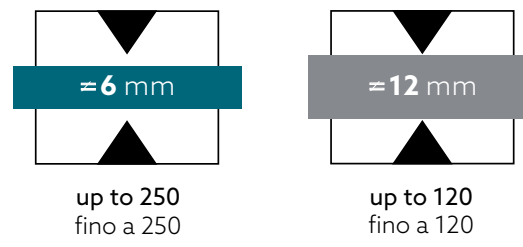

EDGE MACHINING LAVORAZIONI BORDI

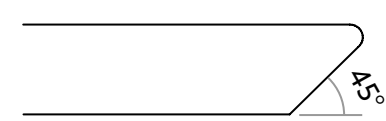

A Reverse angled ridge 45°
Costa a profilo inclinato

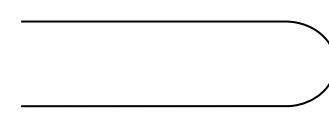

C Full rounded ridge
Costa a toro

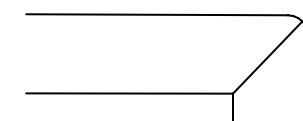

E L-shaped squared ridge
Veletta a vista

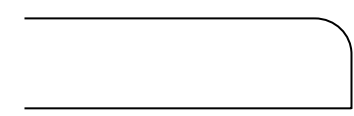

B Rounded straight ridge
Costa pari a tondino

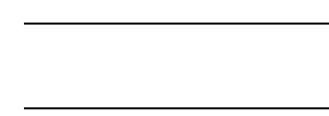

D Double straight squared ridge
Costa pari lati a vista

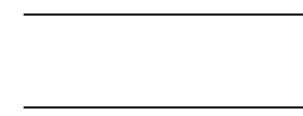

F Raw edge
Taglio grezzo

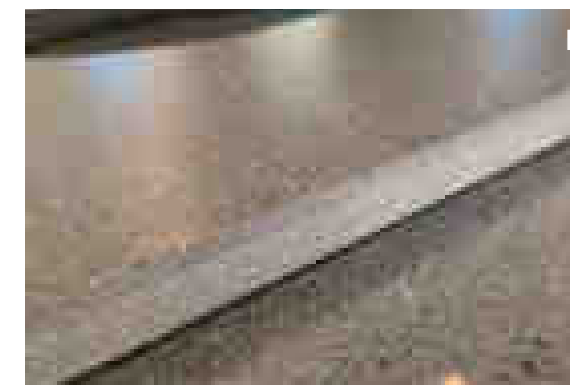

WORKTOP MACHINING LAVORAZIONI TOP

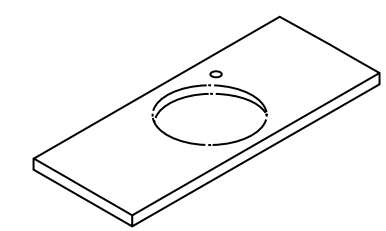

Raw circular or shaped hole
Foro grezzo circolare o sagomato

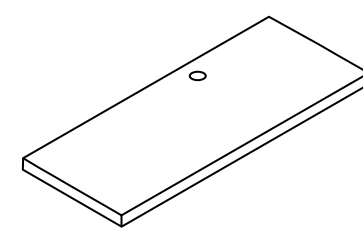

Mixer hole
Foro per miscelatore

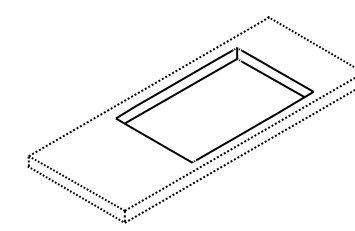

Raw rectangular hole
Foro grezzo rettangolare

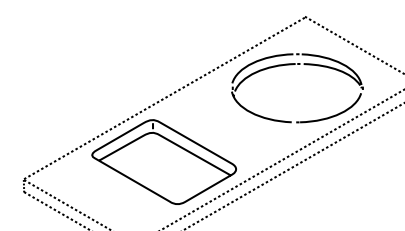

Satin hole
Foro satinato

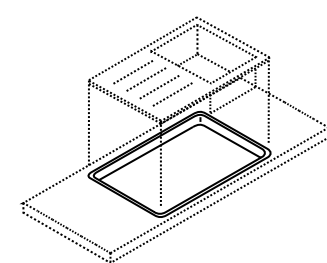

Top-aligned hole
Foro filo top

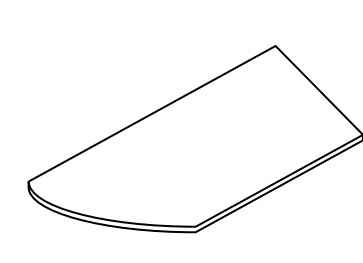

Radiused final
Terminale raggato

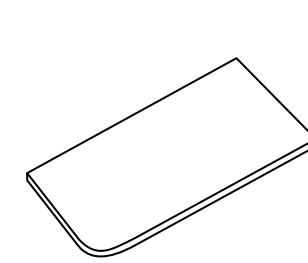

Radiused corner
Angolo raggato

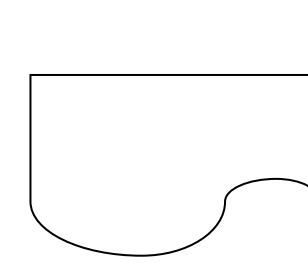

Shaping raw
Sagomatura grezza



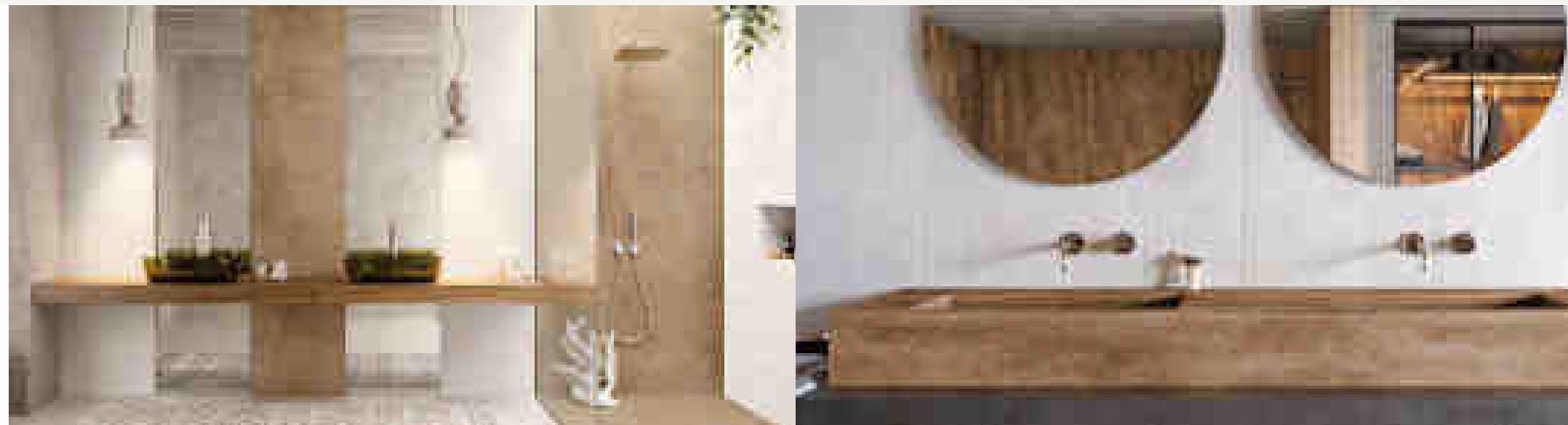

WASHBASINS AND SHOWER TRAYS LAVABI E PIATTI DOCCIA

WASHBASINS LAVABI

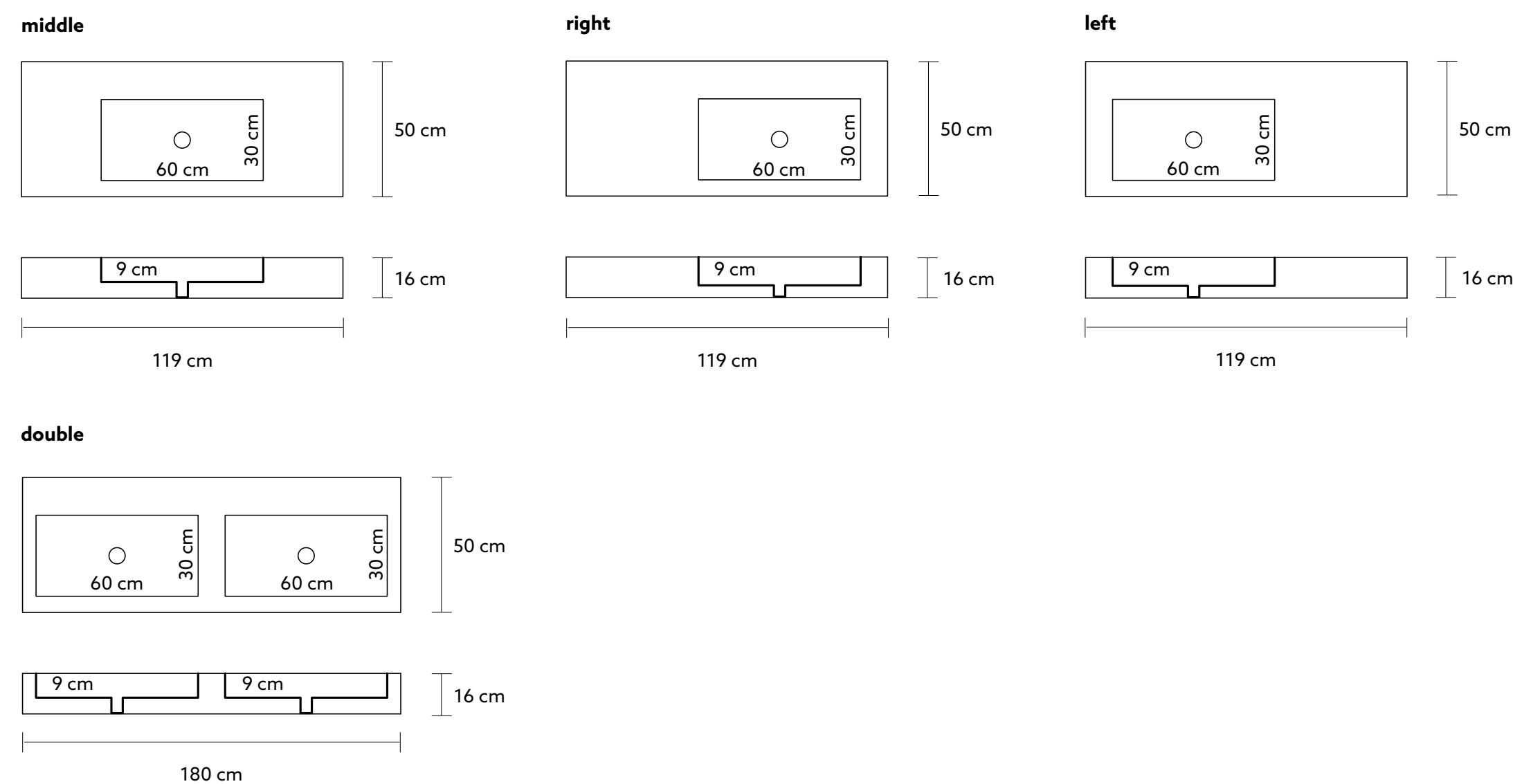

COLOUR COLORE	MODEL MODELLO	SIZE FORMATO CM
all colours / tutti i colori	middle	119x50 48"x19 1/2" ≠6mm
all colours / tutti i colori	left or right	119x50 48"x19 1/2" ≠6mm
all colours / tutti i colori	double	180x50 71"x19 1/2" ≠6mm

SHOWER TRAYS PIATTI DOCCIA

model A

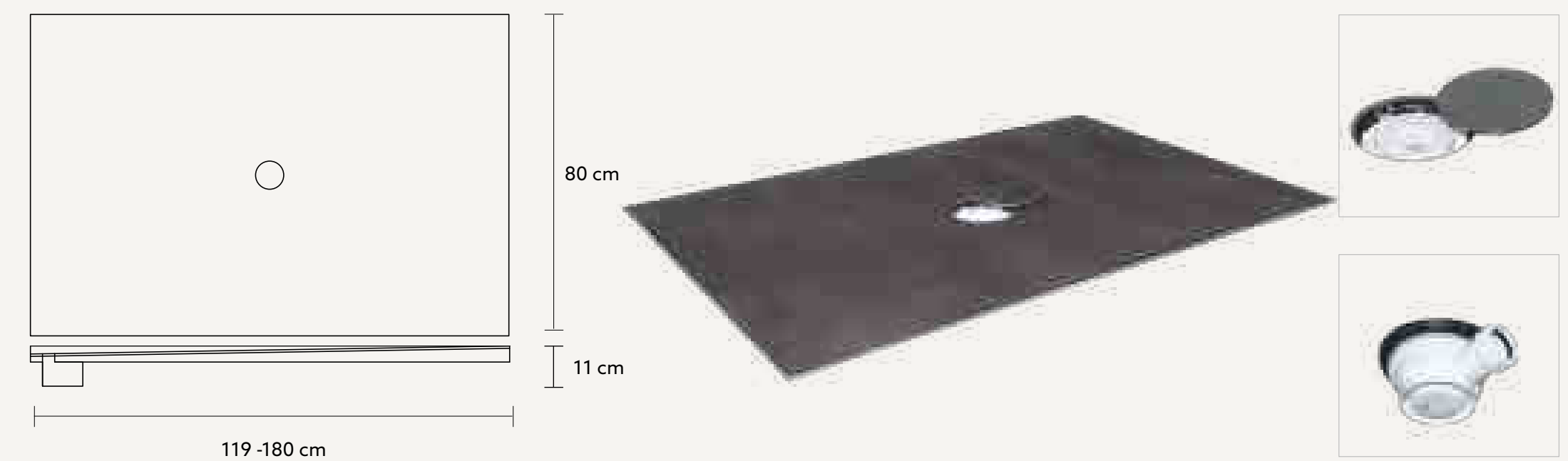

model B



COLOUR COLORE	MODEL MODELLO	SIZE FORMATO CM
all colours / tutti i colori	A (thermoformed / termoformato)	119x80 48"x31 1/2" ≠6mm / ≠12mm
all colours / tutti i colori	B (assembled / assemblato)	119x80 48"x31 1/2" ≠6mm / ≠12mm
all colours / tutti i colori	B (assembled / assemblato)	180x80 71"x31 1/2" ≠6mm

You can find all technical information about shower trays in our brochure "Gigacer Service" and on our web site www.gigacer.it.
Tutte le informazioni tecniche inerenti ai piatti doccia le puoi trovare sulla brochure "Gigacer Service" e sul sito www.gigacer.it

24 MM RAISED FLOORS PAVIMENTI SOPRAELEVATI

The strength of 2 12 mm thick tiles glued together with a special glue grants a modulus of rupture of 18.140 Kgf. ≈24 mm is frostresistant, has a very high breakage load, it is resistant to salts, easy to clean also using pressure washers, resistant to the attack of mould, moss and verdigris treatments, removable, reusable, anti-slip, fire-resistant and very easy to install. ≈24 mm does not change and lasts over time in any climatic conditions, characteristics that are a must for outdoor floor coverings. Installation can be done using different techniques, according to the kind of surface. The porcelain stoneware slabs can be laid using a dry installation system, directly onto gravel or sand substrates as well as with raised installation (i.E. Eterno Ivica Pedestals) or glued. Raised installation is made with a support structure made of polypropylene, prefabricated, load-bearing modules, which can be fix, adjustable and self levelling. They have a minimum height of 37,5 mm and a maximum height of 230mm. Raised installation allows for easy inspection of underlying cabling and circuits without the need for burdensome work. ≈24 mm raised floor is the best solution for residential and commercial destinations such as balconies, paths, access floors, etc., protecting the under-space and easily allowing any kind of technical intervention. A 4 mm joint is requested for water drainage.

La resistenza di 2 lastre di 12 mm di spessore, incollate assieme con colla speciale garantisce un modulo di rottura di 18.140 kgf. ≈24 mm è resistente al gelo, ha un altissimo carico di rottura, è resistente ai sali, facile da pulire anche utilizzando idropulitrici, resistente agli attacchi di muffe, funghi, muschi e trattamenti al verderame. È rimovibile, riutilizzabile, antiscivolo, resistente al fuoco e facile da installare. ≈24 mm non cambia col tempo e resiste a tutte le condizioni climatiche, caratteristiche fondamentali per un pavimento esterno. La posa può essere fatta utilizzando diverse tecniche, secondo il tipo di superficie da ricoprire. Le lastre possono essere installate a secco direttamente su ghiaia, sabbia o altri substrati, possono essere stese su supporti sopraelevati (es. Eterno Ivica Pedestal) o incollate. L'installazione sopraelevata può essere effettuata con una struttura portante di moduli in polipropilene, che possono essere fissi, regolabili e autolivellanti. Hanno una altezza minima di 37,5 mm e massima di 230 mm. L'installazione sopraelevata consente una facile ispezione di cavi o condutture senza dover rompere il pavimento. ≈24 mm pavimento sopraelevato è la migliore soluzione per luoghi residenziali o commerciali come balconi, vialetti, ecc. dal momento che protegge la superficie sottostante e consente ogni tipo di intervento tecnico. Consigliamo una fuga di 4 mm per lo scolo dell'acqua.

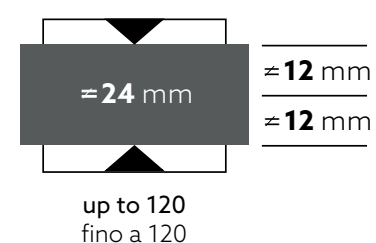

THE ADVANTAGES OF 24 MM I VANTAGGI DEL 24 MM

- › Possibility to have a product with the same tone and surface for indoor and the outdoor spaces
- › Big format 120x120 24 mm thickness
- › Efficient drainage
- › Dry laying
- › Endurance and strength
- › Cleanability
- › Frost resistance

The grout in the 24 mm thickness has the same colour of the tiles.

Some examples using 24 mm

Raised access floors / open terraces / closed terraces / walkways / swimming pools / gardens / shower trays.

- › Possibilità di avere un prodotto con lo stesso tono e superficie posato nelle aree interne ed esterne
- › Grande formato 120x120 in 24mm di spessore
- › Drenaggio efficace
- › Posa a secco
- › Durata e resistenza
- › Pulibilità
- › Ingelività

Lo stucco del bordo del 24 mm è colorato in tinta con il fondo scelto.

Esempi di utilizzo del 24 mm

Pavimento sopraelevati / terrazzi all'aperto / terrazze chiuse / vialetti esterni / facciate ventilate / spiagge piscine / piatti doccia.

POLIPROPYLENE SUPPORTS PIEDINI IN POLIPROPILENE

120 x 120 cm / 48" x 48" 9 pz pcs / lastra slab	60 x 120 cm / 24" x 48" 6 pz pcs / lastra slab	60 x 60 cm / 24" x 24" 4 pz pcs / lastra slab
80 kg	40 kg	20 kg



**SPECIAL TRIMS
PEZZI SPECIALI**

SKIRTING BATTISCOPIA

Battiscopa 60
≠12 mm

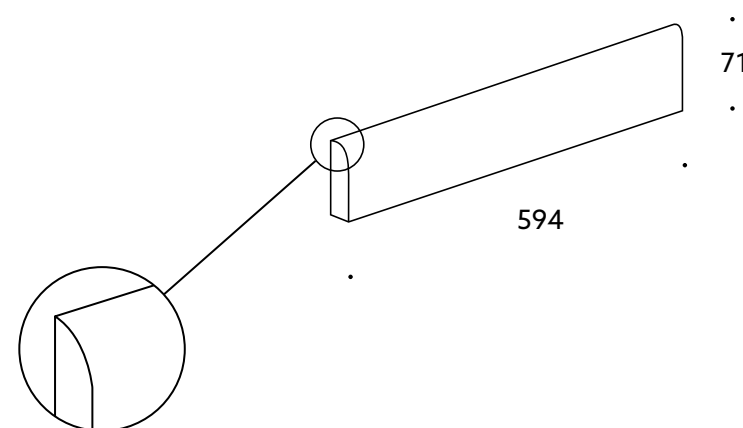

Battiscopa 120
≠6 mm

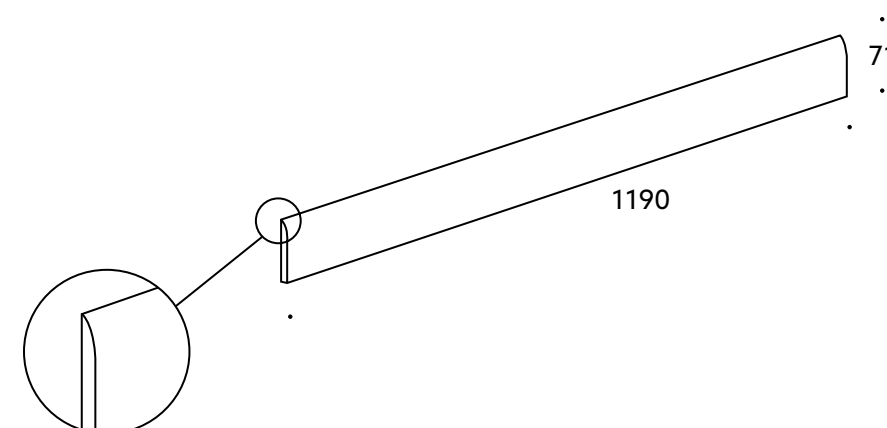

COSTA RETTA STEPTREADS GRADONI COSTA RETTA

Costa retta 60
≠6 mm | ≠12 mm

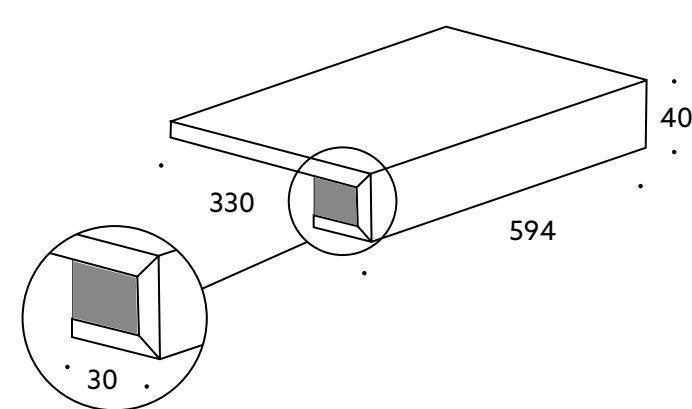

Costa retta 120
≠6 mm | ≠12 mm

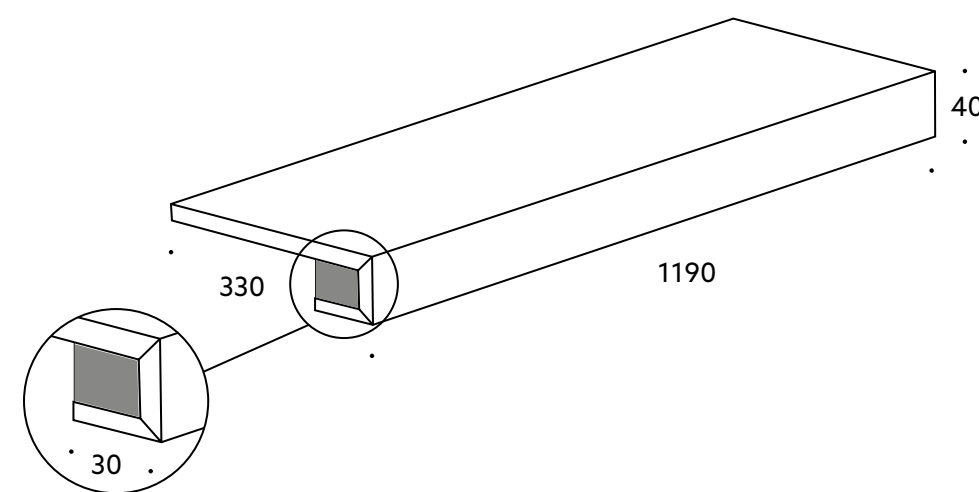

USE

- Steptreads for stairs
- Windowsills
- Terraces and balconies edge finish
- Poolside
- Indoor or outdoor

UTILIZZO

- Gradini per scale
- Davanzali
- Finitura terrazze e balconi
- Bordo piscine
- Interno o esterno

(1)
All sizes are in millimetres
Tutte le misure sono in millimetri

**SPECIAL SERVICES
SERVIZI SPECIALI**



Gigacer Service is the firm's made to measure working service offered on all products. It enables slabs to be cut, perforated, polished and generally adapted to the individual project in line with the requisites of a specific client design. In this way the ceramic slabs can be used both to create decor elements and to personalise or adjust slab dimensions to flooring or decor designs. In this way the ceramic slabs can be matched with, or even identical to, the kitchen worktop, flights of steps, the bathroom worktop and even the basin in an infinity of possible forms and dimensions. Each single piece can be made in accordance with designers' instructions and technical drawings.

Gigacer Service è il servizio di lavorazioni su misura offerto da Gigacer su tutti i suoi prodotti. Consente di tagliare, forare, lucidare e in generale adattare le lastre al singolo progetto, seguendo le indicazioni di uno specifico disegno del cliente. In questo modo le lastre ceramiche possono essere utilizzate sia per realizzare elementi d'arredo, sia per personalizzare o adeguare al progetto le dimensioni di lastre per pavimento o rivestimento. Il pavimento o il rivestimento potrà così essere abbinato o addirittura identico al top cucina, ai gradini della scala, al top bagno o anche allo stesso lavabo, in una infinità di forme e dimensioni. Il pezzo unico viene realizzato anche seguendo le indicazioni e il disegno tecnico del progettista.

CHANGES ON REQUEST MODIFICHE SU RICHIESTA

It is possible to require the feasibility and the quotation for the following changes:

- squared top edge, instead of rounded
- unglazed top edge (on 12mm thickness the multilayer will be visible)
- bespoke sizes: please indicate X and Y in mm.

È possibile richiedere la fattibilità e la quotazione per le seguenti modifiche:

- top squadrato invece che arrotondato
- top non smaltato (nel 12mm sarà visibile il multilayer)
- misure non standard: indicare misura X e Y in mm

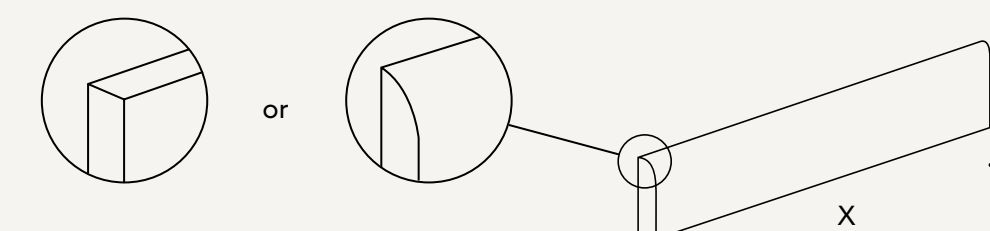

It is possible to request bespoke sizes on X, Y, Z and J. Minimum size 30mm, maximum 1900 for each variable. It is possible to ask for one or both sides closed, if the staircase is open. The piece can be made without nose, only at 90°. All sizes must be specified (A, B and C).

Le misure X, Y, Z e J sono modificabili a piacimento. Misura minima 30mm, massima 1900 per ogni variabile. È possibile richiedere il gradone con chiusura su un lato o su entrambi, nel caso la scala sia aperta. Il pezzo può essere realizzato anche a vela senza rientranza. È necessario indicare tutte le misure richieste (A, B e C).

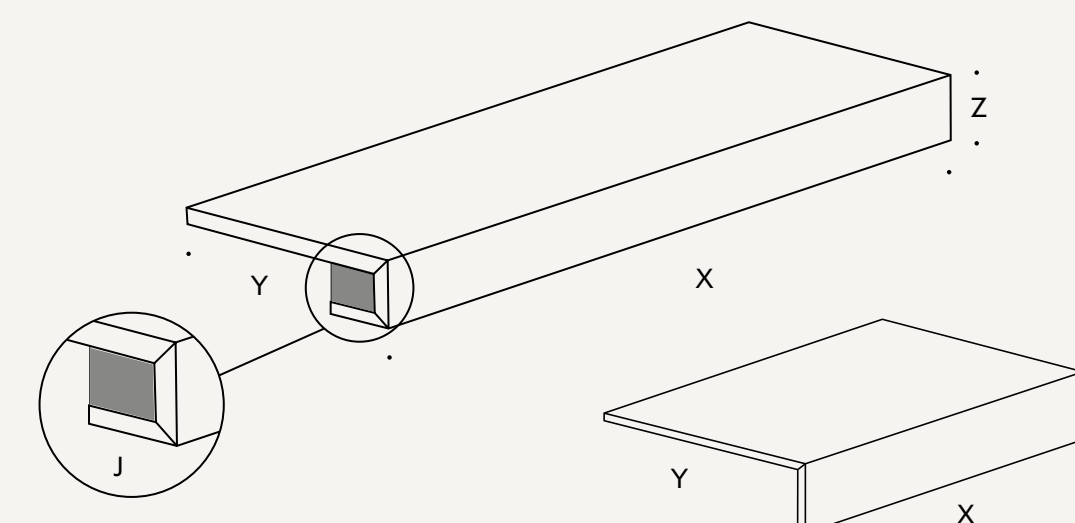

INTENDED USE CLASSIFICATION DESTINAZIONI D'USO

	NEW FLOORS PAVIMENTI NUOVE COSTRUZIONI	FLOOR RENOVATION PAVIMENTI IN RISTRUTTURAZIONI	WALL COVERING RIVESTIMENTI	LIGHT COMMERCIAL COMMERCIALE LEGGERO	HEAVY COMMERCIAL COMMERCIALE PESANTE	OUTDOOR ESTERNI	RAISED FLOOR SOPRELEVATO	COUNTERTOPS AND KITCHENTOPS PIANI DI LAVORO
6 mm	+	++	++	+	--	-	--	-
12 mm	++	+	+	++	++	+	+	-
24 mm	-	-	-	-	++	++	++	-
	floor tiling on screed in new buildings / posa a terra in nuove costruzioni su massetto	floor tiling on screed or on existing floor (in ceramic or natural stone) in buildings under renovation / posa a terra su pavimenti esistenti, in ceramica o pietra naturale, o su massetto in costruzioni in stato di ristrutturazione	wall covering / rivestimento muri	indoor public places subject to medium pedestrian traffic / ambienti pubblici interni a medio traffico	indoor public places subject to heavy pedestrian traffic / ambienti pubblici interni ad alto traffico	outdoor places / ambienti esterni	raised floor with floating structure or pvc supports / pavimenti sovrelevati con struttura flottante o posa su supporti in pvc	

++ consigliato recommended
+ appropriato suitable
- non consigliato not recommended
-- non appropriato not suitable

INSTALLATION SUGGESTION SUGGERIMENTI PER LA POSA

6 mm slabs are resistant, thin, lightweight, easy to handle and cut, fire-resistant, frostproof, environmentally friendly and require no special care for maintenance. 6 mm is an ideal product for interior and exterior cladding. 6 mm slabs are particularly suitable in the case of renovation of residential floors and walls: they can be laid on the existing floor, allowing for a dramatic demolition and disposal cost savings. GIGACER 6 mm is suitable for indoor and outdoor wall covering and it is particularly indicated in all cases where it is preferable not to load too much weight on the building's structure. 6 mm can be combined with the 12 mm slabs of every collection because it has the same caliber and it is perfectly modular with 2 mm joints. 6 mm is a green product: it allows savings in terms of energy consumption, raw materials, packaging and transport. It is a valid alternative to the traditional 12 mm in all those cases where lightness and less thickness represent a determinant variable. 6 mm tiles can be fixed together on the same surface, as the real difference in thickness is minimal.

INSTALLATION SUGGESTIONS

GLUING: Double spreading (on substrate and on the back of the tile)

CUTTING: Standard dry diamond clipper for porcelain tiles, bench machines with diamond disks.

DRILLING: Drills with porcelain drill tips, hollow mills or hose-mounted drill bits (for large size holes), hydrojet. Never use the hammer function when drilling, and cool with water while drilling.

Le lastre di 6 mm sono: resistenti, sottili, leggere, facili da movimentare e da tagliare, resistenti al fuoco, ingelive, ecocompatibili e non necessitano di particolari accorgimenti per la manutenzione. È un prodotto ideale per pavimenti e rivestimenti interni ed esterni, ed è particolarmente adatto nel caso di ristrutturazione di pavimentazioni e rivestimenti residenziali: si applica sull'esistente senza opere di demolizione e relativi costi di smaltimento. Il nostro porcellanato sottile è abbinabile ai pavimenti con 2 mm di fuga della stessa collezione in spessori diversi, dei quali mantiene non solo le stesse caratteristiche estetiche, ma anche il medesimo calibro e modularità. Il 6 mm è un prodotto dal design ecologico: lo spessore ridotto comporta un minor impatto ambientale in termini di consumo di energia, materie prime, imballo e trasporti. Costituisce una valida alternativa al gres porcellanato di spessore tradizionale in tutti i casi in cui il minor spessore e la leggerezza costituiscono un fattore determinante. In fase di posa, le lastre di spessore 6 mm risultano perfettamente complanari.

SUGGERIMENTI PER LA POSA

INCOLLAGGIO: Doppia spalmatura (sul fondo e sul retro della piastrella).

TAGLIO: Normale taglierina da cantiere, sega a dischi diamantati.

FORATURA: trapani a punta per gres porcellanato, frese a tazza, idrogetto. Non usare il percussore e raffreddare con acqua nel punto di contatto.

SHADE VARIATION INDEX INDICE DI STONALIZZAZIONE

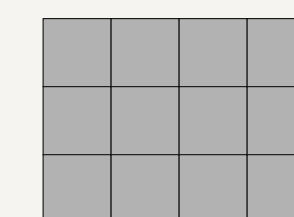

V1 / LOW
Monochromatic product
Prodotto monocromatico

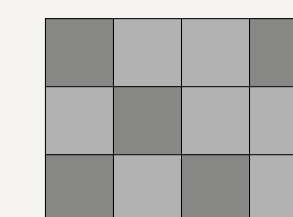

V2 / MODERATE
Product with light chromatic variation
Prodotto con leggera variazione cromatica

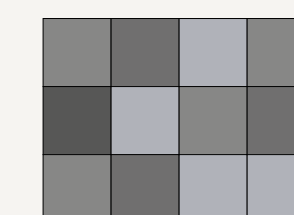

V3 / HIGH
Product with high chromatic variation
Prodotto con marcata variazione cromatica

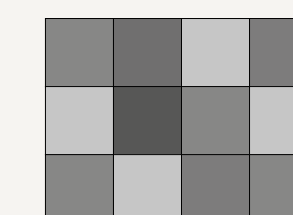

V4 / VERY HIGH
Product with very high chromatic variation
Prodotto con forte variazione cromatica

Surfaces / Superficie	Shade variation Stonalizzazione
Inclusioni Soave	V3
Inclusioni Extrafine	V3

CALIBER CALIBRI

Our slabs are always rectified and the table below indicates their final size in millimetres. Our standard caliber is 09 and all sizes with the same caliber, when multiples, are modular with 2 mm joint spacing.

Le nostre lastre sono sempre rettificate e hanno dimensioni finali in millimetri come da tabella. Il calibro standard è lo 09 e i formati dello stesso calibro multipli tra loro sono modulari con 2 mm di fuga.

NOMINAL SIZE (CM) FORMATO NOMINALE (CM)	RECTIFIED SIZE (MM) FORMATO RETTIFICATO (MM)	CALIBER CALIBRO
120x250	1190x2500	09
60x250	594x2500	09
120x120	1190x1190	09
60x120	594x1190	09
60x60	594x594	09
30x60	296x594	09

MODULARITY MODULARITÀ

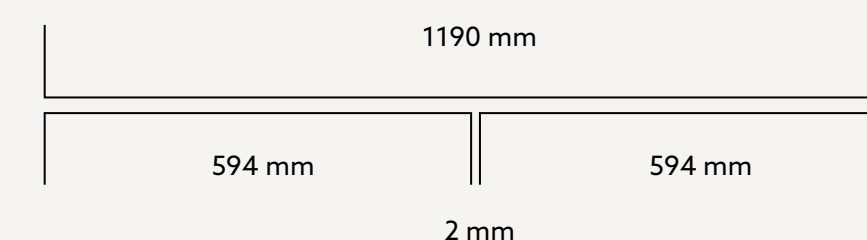

TECHNICAL SPECIFICATION CARATTERISTICHE TECNICHE

PORCELAIN SLABS / LASTRE DI GRES PORCELLANATO
ISO 13006 - G - BIA UGL (E ≤ 0,5%) UNI EN 14411 - G -

	TECHNICAL SPECIFICATIONS CARATTERISTICHE TECNICHE	STANDARD NORMA ISO	THICKNESS SPESSORE	INTERNATIONAL STANDARDS VALORI PRESCRITTI DALLE NORME	AVERAGE GIGACER VALUE VALORE MEDIO GIGACER
	DIMENSIONAL CHARACTERISTICS CARATTERISTICHE DIMENSIONALI	ISO 10545-2	-	s > 410	
	SIDES LATI		-	± 0,6%	± 0,2%
	THICKNESS SPESSORE		-	± 5%	± 3%
	STRAIGHTNESS OF EDGES RETTILINEITÀ DEGLI SPIGOLI		-	± 0,5%	± 0,2%
	RECTANGULARITY ORTOGONALITÀ		-	± 0,6%	± 0,2%
	SURFACE FLATNESS PLANARITÀ		-	± 0,5%	± 0,2%
	WATER ABSORPTION ASSORBIMENTO D'ACQUA		ISO 10545-3	-	≤ 0,5%
	BENDING STRENGTH RESISTENZA ALLA FLESSIONE	ISO 10545-4	≠ 6 mm	≥ 35n/mm ²	≥ 40 n/mm ²
			≠ 12 mm	≥ 35n/mm ²	≥ 40 n/mm ²
	MODULUS OF RUPTURE MODULO DI ROTTURA	ISO 10545-4	≠ 6 mm	> 700n (sp. < 7,5mm)	> 700 n
			≠ 12 mm	> 1.300n (sp. ≥ 7,5mm)	≥ 4000 n
			≠ 24 mm	> 1.300n (sp. ≥ 7,5mm)	18,14 kn (=18.140 kgf)
	RESISTANCE TO DEEP ABRASION RESISTENZA ALL'ABRASIONE PROFONDA	ISO 10545-6	-	≤ 175 mm ³	≤ 145 mm ³
	COEFFICIENT OF LINEAR THERMAL EXPANSION COEFFICIENTE DI DILATAZIONE TERMICA LINEARE	ISO 10545-8	-	≤ 9X10 6°c 1	≤ 7X10 6°c 1
	RESISTANCE TO THERMAL SHOCKS RESISTENZA AGLI SBALZI TERMICI	-	-	AVAILABLE METHOD METODO DISPONIBILE	RESISTANT RESISTE
	FROST RESISTANCE RESISTENZA AL GELO	ISO 10545-12	-	AVAILABLE METHOD METODO DISPONIBILE	RESISTANT RESISTE
	RESISTANCE TO CHEMICAL ATTACKS RESISTENZA ALL'ATTACCO CHIMICO	ISO 10545-13	-	MIN. UB	RESISTANT RESISTE
	STAIN RESISTANCE RESISTENZA ALLE MACCHIE	ISO 10545-14	-	AVAILABLE METHOD METODO DISPONIBILE	RESISTANT RESISTE

We produce technical unglazed porcelain stoneware slabs, and some light impurities and dots must be considered as a standard feature of the product. / Trattandosi di un prodotto tecnico a solo impasto senza smalto alcune impurità e puntinature visibili nei colori chiari sono da considerarsi una caratteristica tecnica del prodotto.

TECHNICAL NOTES NOTE TECNICHE

PORCELAIN SLABS - COEFFICIENT OF FRICTION / LASTRE DI GRES PORCELLANATO - COEFFICIENTE DI ATTRITO
ISO 13006 - G - BIA UGL (E ≤ 0,5%) UNI EN 14411 - G -

	SURFACES SUPERFICI	THICKNESS SPESSORE	DIN 51130	DIN 51097	BCR	BRITISH PENDULUM BS7976	R9729 UPI/EMPA	DCOF (SECTION 9.6 ANSI A 137.1.2012)		
	INCLUSIONI	Extrafine	Mat	≠6 mm	R10	A	> 0,40	-	GS1	> 0,42 wet
		Soave	Mat	≠12 mm ≠24 mm	R10	A + B*	> 0,40	> 36 WET	GS2/GB1	> 0,42 wet
			Bocciardato		R10	A + B	> 0,40	> 36 WET	GS2/GB1	> 0,42 wet
			Bocciardato Antislip		R11	A + B + C	> 0,40	> 36 WET	GS2/GB1	> 0,42 wet

* Average value / Valore medio

The values of slip resistance and of static and dynamic friction coefficient shown in the catalogue, and in the web site are merely indicative and non-binding. Any possible specific requirement must be confirmed by us at the order and anyway always before the installation.

/ I valori di resistenza allo scivolamento, coefficiente di attrito statico e dinamico, riportati sul catalogo e sul sito, sono da ritenersi puramente indicativi e non vincolanti. Ogni eventuale specifica necessità dovrà essere da noi confermata al momento dell'ordine e comunque sempre prima della posa.

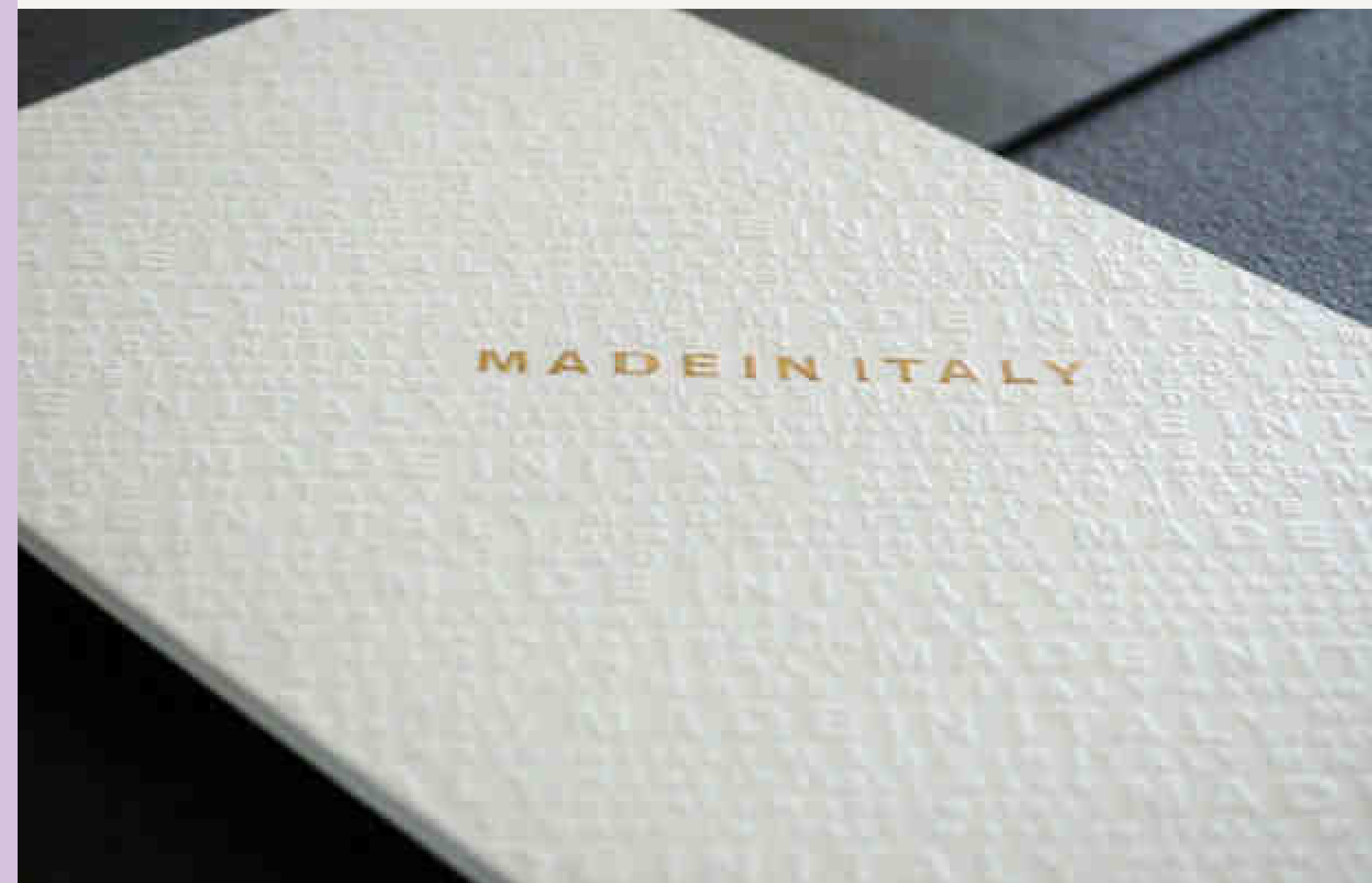

PACKAGING IMBALLI

We pay close attention to the 6 mm products packaging, to avoid any risk of breakage during shipping. The cardboard used come from recycled sources 100%, and wood, fumigated according to ISPM-15, supports the weight of any pallet (gigacer pallets) stacked. It is important to stack only pallets of the same size. Gigacer assumes no responsibility for damages caused by incorrect handling of the material loading or unloading, unauthorized handling or accidents of any kind.

Curiamo con particolare attenzione gli imballi del materiale 6 mm per scongiurare qualsiasi rischio di rottura dovuta alle sollecitazioni del viaggio. Il cartone utilizzato proviene al 100% da fonti riciclate e il legno, fumigato secondo le norme ISPM-15, sostiene il peso di eventuali pallet (sempre Gigacer) sovrapposti scaricandolo a terra. È importante sovrapporre i pallet dello stesso formato, e non euro pallet con pallet 120x120. Gigacer non si assume nessuna responsabilità per danni causati al materiale da errate manovre di carico o scarico, da movimentazioni non autorizzate o da eventi accidentali di qualsiasi tipo.

SIZE (CM) FORMATO	PALLET (CM)	PCS/BX PEZZI X COLLO	SQM/BX M ² X COLLO	KG/BX KG X COLLO	BX/PLT COLLI X PALLET	SQM/PLT M ² X PALLET	KG/PLT KG X PALLET
24 mm							
120x120	120x120	1	1,44	82,00	12	17,28	1010
60x120	120x120	1	0,72	41,00	24	17,28	1010
60x60	120x120	1	0,36	20,50	48	17,28	1010
12 mm							
120x120	120x120	1	1,44	40,30	36	51,84	1482
60x120	120x120	2	1,44	40,30	36	51,84	1482
60x60	120x120	3	1,08	30,20	48	51,84	1482
30x60	120x120	4	0,72	20,20	72	51,84	1482
skirting / battiscopa 60x7,1	-	10	-	12,00	-	-	-
costa retta step gradino costa retta 60x33x4	-	4	-	26,00	-	-	-
costa retta step gradino costa retta 120x33x4	-	2	-	26,00	-	-	-
6 mm							
120x250	272x133x42h	1	3,00	42,60	22	66,00	1038
60x250	272x133x42h	1	1,50	21,00	44	66,00	1037
120x120	124x137	2	2,88	41,00	20	57,60	860
60x120	124x137	4	2,88	40,80	24	69,12	1021
60x60	124x137	4	1,44	20,50	40	57,60	848
30x60	124x137	8	1,44	20,50	48	69,12	1014
skirting / battiscopa 120x7,1	-	8	-	11,00	-	-	-
costa retta step gradino costa retta 60x33x4	-	4	-	26,00	-	-	-
costa retta step gradino costa retta 120x33x4	-	2	-	26,00	-	-	-

CERTIFICATIONS CERTIFICAZIONI

GIGACER has achieved the process certifications ISO 9001:2015 e ISO 14001:2015. GIGACER has achieved the process certifications UNI EN 14411:2012. The quality of GIGACER products is constantly monitored with tests made by the main international certification laboratories.

GIGACER ha conseguito le certificazioni di processo ISO 9001:2015 e ISO 14001:2015. GIGACER ha conseguito le certificazioni UNI EN 14411:2012. La qualità dei prodotti GIGACER viene controllata costantemente tramite test effettuati dai principali laboratori ed enti di certificazione internazionali.

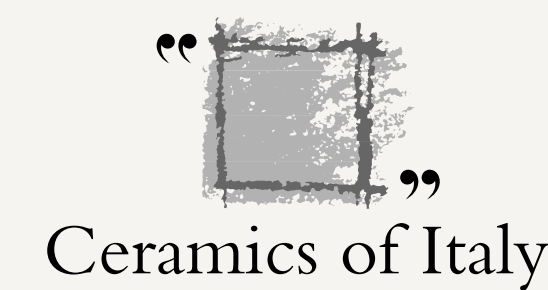

MADE IN ITALY
MADE IN FAENZA

Real colours and decorations might slightly differ from those depicted in this catalogue. / Quanto contenuto nel catalogo è puramente indicativo riguardo a colori e decorazioni.



GIGACER S.P.A.
via Caltagirone, n.72 / 48018 Faenza (RA) ITALY
Tel. +39 0546 637 111 / Fax +39 0546 637 127
info@gigacer.it
gigacer.it

